

AK3950/..-5.0-GREEN



Technical Data

Wire Sizes		Insulating Material	
Solid min	0.08 mm ²	Material	PA 6.6
Solid max	2.5 mm ²	Flammability Class	UL 94 V-0
Stranded (flexible) min	0.08 mm ²	Temperatures	
Stranded (flexible) max	2.5 mm ²	Operating Temperature	-30 °C - 105 °C
Stranded with Ferrule min	0.14 mm ²	Wave Soldering Process	
Stranded with Ferrule max	1.5 mm ²	Soldering Temperature, recommended	-
Dimensions		Peak Soldering Time, recommended	-
Stripped Length	8.5 mm	Reflow Process	
PCB Hole Diameter	-	Soldering Temperature, recommended	-
Materials		Peak Soldering Time, recommended	-
Contact Spring	Copper Alloy		
Tension Spring	Stainless Steel		

Colours

 GREEN, RAL 6018  PEBBLE GREY, RAL 7032

Colours according to RAL, there may be variations on colour due to production conditions. Special colours on request.

Counterparts (Spacing 5.0 mm)

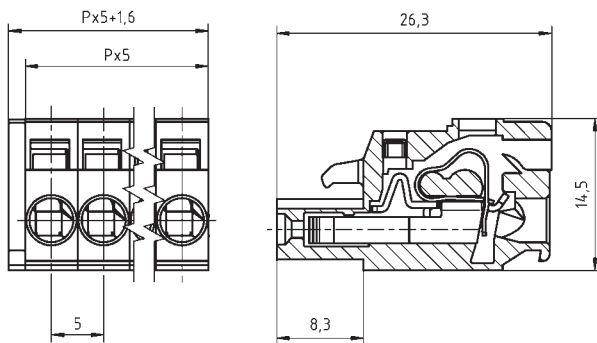

Pin Strip		
STL950	STL955	STL975



Order Data (Spacing 5.0 mm)



Poles	Width (mm)	Article Designation	Article Number	PU
2	11.60	AK3950/2-5.0-GREEN	53950020001D	50
3	16.60	AK3950/3-5.0-GREEN	53950030001D	50
4	21.60	AK3950/4-5.0-GREEN	53950040001D	50
5	26.60	AK3950/5-5.0-GREEN	53950050001D	50
6	31.60	AK3950/6-5.0-GREEN	53950060001D	50
7	36.60	AK3950/7-5.0-GREEN	53950070001D	50
8	41.60	AK3950/8-5.0-GREEN	53950080001D	50
9	46.60	AK3950/9-5.0-GREEN	53950090001D	50
10	51.60	AK3950/10-5.0-GREEN	53950100001D	50
11	56.60	AK3950/11-5.0-GREEN	53950110001D	50
12	61.60	AK3950/12-5.0-GREEN	53950120001D	50
13	66.60	AK3950/13-5.0-GREEN	53950130001D	50
14	71.60	AK3950/14-5.0-GREEN	53950140001D	50
15	76.60	AK3950/15-5.0-GREEN	53950150001D	50
16	81.60	AK3950/16-5.0-GREEN	53950160001D	50
17	86.60	AK3950/17-5.0-GREEN	53950170001D	50
18	91.60	AK3950/18-5.0-GREEN	53950180001D	50
19	96.60	AK3950/19-5.0-GREEN	53950190001D	50
20	101.60	AK3950/20-5.0-GREEN	53950200001D	50
21	106.60	AK3950/21-5.0-GREEN	53950210001D	50
22	111.60	AK3950/22-5.0-GREEN	53950220001D	50
23	116.60	AK3950/23-5.0-GREEN	53950230001D	50
24	121.60	AK3950/24-5.0-GREEN	53950240001D	50

Accessories

Figure	Designation	Article Number
	Bridge, 2-pole, insulated, BRI/2-5.0/5.08-LIGHT GREY	50000000006
	Bridge, 3-pole, insulated, BRI/3-5.0/5.08-LIGHT GREY	50000000007
	Coding Star CS1-5.0/5.08-RED	50000000021

See pages 282 ff for detail and general accessories and see pages 12/13 concerning services.

Ratings

Usegroup	c 					
	B	C	D			
Rated Voltage	300 V	-	300 V	250 V		
Rated Current	15 A	-	10 A	12 A		
Overvoltage Category				III		
Rated Wire Size			min	max		
	solid	AWG 28-12	-	AWG 28-12	0.5 mm ² (5 A)	2.5 mm ² (12 A)
	stranded	AWG 28-12	-	AWG 28-12	0.5 mm ² (5 A)	2.5 mm ² (12 A)
Test Voltage	1.6 kV		-	1.6 kV	4.0 kV	
Pollution Degree	3					