

AK3001/..FD-10.0-PEBBLE GREY

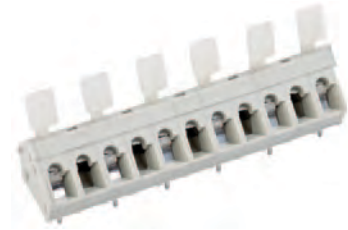



2- to n-poles



Technical Data

Wire Sizes		Insulating Material	
Solid min	0.08 mm ²	Material	PA 6.6
Solid max	2.5 mm ²	Flammability Class	UL 94 V-0
Stranded (flexible) min	0.14 mm ²	Temperatures	
Stranded (flexible) max	2.5 mm ²	Operating Temperature	-30 °C - 105 °C
Stranded with Ferrule min	0.14 mm ²	Wave Soldering Process	
Stranded with Ferrule max	1.5 mm ²	Soldering Temperature, recommended	265 °C
Dimensions		Peak Soldering Time, recommended	3 s / 10 s
Stripped Length	6.0 mm	Reflow Process	
PCB Hole Diameter	1.1 mm	Soldering Temperature, recommended	-
Materials		Peak Soldering Time, recommended	-
Solder Tag	Copper Alloy		
Tension Spring	Stainless Steel		

Colours

	PEBBLE GREY, RAL 7032		GREEN, RAL 6018
	ORANGE, RAL 2011		BLUE, RAL 5015
	LIGHT GREEN, similar RAL 6018		

Colours according to RAL, there may be variations on colour due to production conditions. Special colours on request.

Order Data (Spacing 10.0 mm)

Poles	Width (mm)	Article Designation	Article Number	PU
2	17.90	AK3001/2FD-10.0-PEBBLE GREY	53001020061E	100
3	27.90	AK3001/3FD-10.0-PEBBLE GREY	53001030061E	100
4	37.90	AK3001/4FD-10.0-PEBBLE GREY	53001040061E	100
5	47.90	AK3001/5FD-10.0-PEBBLE GREY	53001050061E	100
6	57.90	AK3001/6FD-10.0-PEBBLE GREY	53001060061D	50
7	67.90	AK3001/7FD-10.0-PEBBLE GREY	53001070061D	50
8	77.90	AK3001/8FD-10.0-PEBBLE GREY	53001080061D	50
9	87.90	AK3001/9FD-10.0-PEBBLE GREY	53001090061D	50
10	97.90	AK3001/10FD-10.0-PEBBLE GREY	53001100061D	50
11	107.90	AK3001/11FD-10.0-PEBBLE GREY	53001110061D	50
12	117.90	AK3001/12FD-10.0-PEBBLE GREY	53001120061D	50
13	127.90	AK3001/13FD-10.0-PEBBLE GREY	53001130061D	50
14	137.90	AK3001/14FD-10.0-PEBBLE GREY	53001140061D	50
15	147.90	AK3001/15FD-10.0-PEBBLE GREY	53001150061D	50
16	157.90	AK3001/16FD-10.0-PEBBLE GREY	53001160061D	50
17	167.90	AK3001/17FD-10.0-PEBBLE GREY	53001170061D	50
18	177.90	AK3001/18FD-10.0-PEBBLE GREY	53001180061D	50
19	187.90	AK3001/19FD-10.0-PEBBLE GREY	53001190061D	50
20	197.90	AK3001/20FD-10.0-PEBBLE GREY	53001200061D	50
21	207.90	AK3001/21FD-10.0-PEBBLE GREY	53001210061D	50
22	217.90	AK3001/22FD-10.0-PEBBLE GREY	53001220061D	50
23	227.90	AK3001/23FD-10.0-PEBBLE GREY	53001230061D	50
24	237.90	AK3001/24FD-10.0-PEBBLE GREY	53001240061D	50

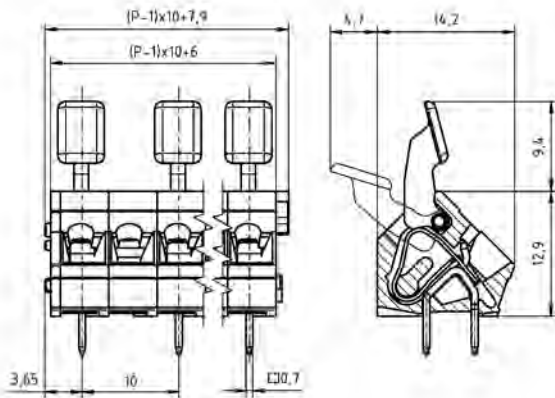

Ratings

Usegroup	c RALUS			VDE	
	B	C	D		
Rated Voltage	300 V	300 V	-	1000 V	
Rated Current	15 A	15 A	-	24 A	
Rated Wire Size				min	max
	solid	AWG 28-14	AWG 28-14	0.5 mm ²	2.5 mm ²
	stranded	AWG 28-14	AWG 28-14	0.5 mm ²	2.5 mm ²
Test Voltage	1.6 kV	1.6 kV	-	3.5 kV	