

AK3001/..KD-10.0-PEBBLE GREY

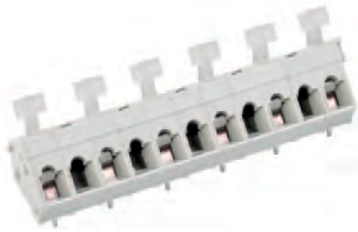



2- to n-poles



Technical Data

Wire Sizes		Insulating Material	
Solid min	0.08 mm ²	Material	PA 6.6
Solid max	2.5 mm ²	Flammability Class	UL 94 V-0
Stranded (flexible) min	0.14 mm ²	Temperatures	
Stranded (flexible) max	2.5 mm ²	Operating Temperature	-30 °C - 105 °C
Stranded with Ferrule min	0.14 mm ²	Wave Soldering Process	
Stranded with Ferrule max	1.5 mm ²	Soldering Temperature, recommended	265 °C
Dimensions		Peak Soldering Time, recommended	3 s / 10 s
Stripped Length	6.0 mm	Reflow Process	
PCB Hole Diameter	1.1 mm	Soldering Temperature, recommended	-
Materials		Peak Soldering Time, recommended	-
Solder Tag	Copper Alloy		
Tension Spring	Stainless Steel		

Colours

	PEBBLE GREY, RAL 7032		GREEN, RAL 6018
	ORANGE, RAL 2011		BLUE, RAL 5015
	LIGHT GREEN, similar RAL 6018		

Colours according to RAL, there may be variations on colour due to production conditions. Special colours on request.

Order Data (Spacing 10.0 mm)

Poles	Width (mm)	Article Designation	Article Number	PU
2	17.90	AK3001/2KD-10.0-PEBBLE GREY	53001020041E	100
3	27.90	AK3001/3KD-10.0-PEBBLE GREY	53001030041E	100
4	37.90	AK3001/4KD-10.0-PEBBLE GREY	53001040041E	100
5	47.90	AK3001/5KD-10.0-PEBBLE GREY	53001050041E	100
6	57.90	AK3001/6KD-10.0-PEBBLE GREY	53001060041D	50
7	67.90	AK3001/7KD-10.0-PEBBLE GREY	53001070041D	50
8	77.90	AK3001/8KD-10.0-PEBBLE GREY	53001080041D	50
9	87.90	AK3001/9KD-10.0-PEBBLE GREY	53001090041D	50
10	97.90	AK3001/10KD-10.0-PEBBLE GREY	53001100041D	50
11	107.90	AK3001/11KD-10.0-PEBBLE GREY	53001110041D	50
12	117.90	AK3001/12KD-10.0-PEBBLE GREY	53001120041D	50
13	127.90	AK3001/13KD-10.0-PEBBLE GREY	53001130041D	50
14	137.90	AK3001/14KD-10.0-PEBBLE GREY	53001140041D	50
15	147.90	AK3001/15KD-10.0-PEBBLE GREY	53001150041D	50
16	157.90	AK3001/16KD-10.0-PEBBLE GREY	53001160041D	50
17	167.90	AK3001/17KD-10.0-PEBBLE GREY	53001170041D	50
18	177.90	AK3001/18KD-10.0-PEBBLE GREY	53001180041D	50
19	187.90	AK3001/19KD-10.0-PEBBLE GREY	53001190041D	50
20	197.90	AK3001/20KD-10.0-PEBBLE GREY	53001200041D	50
21	207.90	AK3001/21KD-10.0-PEBBLE GREY	53001210041D	50
22	217.90	AK3001/22KD-10.0-PEBBLE GREY	53001220041D	50
23	227.90	AK3001/23KD-10.0-PEBBLE GREY	53001230041D	50
24	237.90	AK3001/24KD-10.0-PEBBLE GREY	53001240041D	50

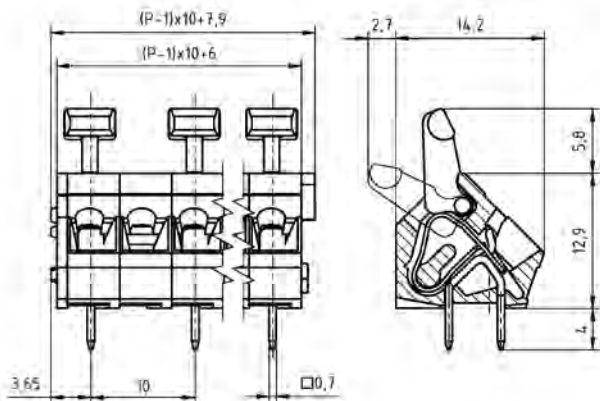

Ratings



Usegroup	B	C	D		
Rated Voltage	300 V	300 V	-	1000 V	
Rated Current	15 A	15 A	-	24 A	
Rated Wire Size				min	max
	solid	AWG 28-14	AWG 28-14	0.5 mm ²	2.5 mm ²
	stranded	AWG 28-14	AWG 28-14	0.5 mm ²	2.5 mm ²
Test Voltage	1.6 kV	1.6 kV	-	3.5 kV	